

650V N-Channel Multi-EPI Super-JMOSFET

General Description

This Power MOSFET is produced using Silkor's Advanced Super-Junction technology. This advanced technology has been especially tailored to minimize conduction loss, provide superior switching performance, and withstand high energy pulse in the avalanche and commutation mode. These devices are well suited for AC/DC power conversion in switching mode operation for higher efficiency.

Features

- 11A, 650V, $R_{DS(on)max} = 380m\Omega @ V_{GS} = 10V$
- Low gate charge (typical 15.5nC)
- High ruggedness
- Fast switching
- 100% avalanche tested
- Improved dv/dt capability

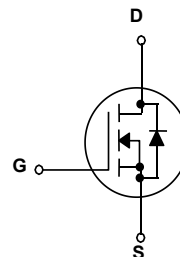
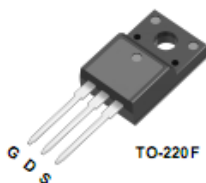

Absolute Maximum Ratings

$T_C = 25^\circ\text{C}$ unless otherwise noted

Symbol	Parameter	SL11N65CF1	Units
V_{DSS}	Drain-Source Voltage	650	V
I_D	Drain Current - Continuous ($T_C = 25^\circ\text{C}$) - Continuous ($T_C = 100^\circ\text{C}$)	11	A
		7	A
I_{DM}	Drain Current - Pulsed (Note 1)	33	A
V_{GSS}	Gate-Source Voltage	± 30	V
EAS	Single Pulsed Avalanche Energy (Note 2)	483	mJ
I_{AR}	Avalanche Current (Note 1)	11	A
E_{AR}	Repetitive Avalanche Energy	6.25	mJ
dv/dt	Peak Diode Recovery dv/dt (Note 3)	20	V/ns
	MOSFET dv/dt	100	
P_D	Power Dissipation ($T_C = 25^\circ\text{C}$) - Derate above 25°C	28	W
		0.22	W/ $^\circ\text{C}$
T_J, T_{STG}	Operating and Storage Temperature Range	-55 to +150	$^\circ\text{C}$
T_L	Maximum lead temperature for soldering purposes, 1/8" from case for 5 seconds	300	$^\circ\text{C}$

* Drain current limited by maximum junction temperature.

Thermal Characteristics

Symbol	Parameter	SL11N65CF1	Units
$R_{\theta JC}$	Thermal Resistance, Junction-to-Case	4.5	$^\circ\text{C}/\text{W}$
$R_{\theta JS}$	Thermal Resistance, Case-to-Sink Typ.	--	$^\circ\text{C}/\text{W}$
$R_{\theta JA}$	Thermal Resistance, Junction-to-Ambient	62.5	$^\circ\text{C}/\text{W}$

Electrical Characteristics

$T_C = 25^\circ\text{C}$ unless otherwise noted

Symbol	Parameter	Test Conditions	Min	Typ	Max	Units
Off Characteristics						
BV _{DSS}	Drain-Source Breakdown Voltage	V _{GS} = 0 V, I _D = 1 mA	650	--	--	V
		V _{GS} = 0 V, I _D = 1 mA, T _J = 150°C	650	--	--	
I _{DSS}	Zero Gate Voltage Drain Current	V _{DS} = 600 V, V _{GS} = 0 V	--	--	1	uA
		V _{DS} = 480 V, T _C = 125°C	--	2	--	uA
I _{GSSF}	Gate-Body Leakage Current, Forward	V _{GS} = 30 V, V _{DS} = 0 V	--	--	100	nA
I _{GSSR}	Gate-Body Leakage Current, Reverse	V _{GS} = -30 V, V _{DS} = 0 V	--	--	-100	nA

On Characteristics

V _{GS(th)}	Gate Threshold Voltage	V _{DS} = V _{GS} , I _D = 0.8mA	2.5	--	4.5	V
R _{DS(on)}	Static Drain-Source On-Resistance	V _{GS} = 10 V, I _D = 4.0 A	--	318	380	mΩ
R _G	Gate resistance	F=1MHZ	--	1.0	--	Ω

Dynamic Characteristics

C _{iss}	Input Capacitance	V _{DS} = 400 V, V _{GS} = 0 V, f = 250 KHZ	--	628	--	pF
C _{oss}	Output Capacitance		--	20	--	pF
C _{o(tr)}	Time Related Output Capacitance	V _{DS} = 0V to 400 V, V _{GS} = 0 V	--	239	--	pF
C _{o(er)}	Energy Related Output Capacitance		--	30	--	pF

Switching Characteristics

t _{d(on)}	Turn-On Delay Time	V _{DD} = 400 V, I _D = 4.0A, R _G = 10 Ω (Note 4, 5)	--	8	--	ns
t _r	Turn-On Rise Time		--	7	--	ns
t _{d(off)}	Turn-Off Delay Time		--	30	--	ns
t _f	Turn-Off Fall Time		--	8	--	ns
Q _g	Total Gate Charge	V _{DS} = 400 V, I _D = 4.0A, V _{GS} = 10 V (Note 4, 5)	--	15.5	--	nC
Q _{gs}	Gate-Source Charge		--	3.0	--	nC
Q _{gd}	Gate-Drain Charge		--	7.9	--	nC

Drain-Source Diode Characteristics and Maximum Ratings

I _S	Maximum Continuous Drain-Source Diode Forward Current	--	--	11	A	
I _{SM}	Maximum Pulsed Drain-Source Diode Forward Current	--	--	33	A	
V _{SD}	Drain-Source Diode Forward Voltage	V _{GS} = 0 V, I _S = 4.0A	--	--	1.2 V	
t _{rr}	Reverse Recovery Time	V _{DD} = 400 V, I _S = 4.0A, dI _F / dt = 100 A/us (Note 4)	--	221	--	ns
Q _{rr}	Reverse Recovery Charge		--	1.8	--	uC

Notes:

1. Repetitive Rating : Pulse width limited by maximum junction temperature
2. L = 79 mH, I_{AS} = 2.5A, V_{DD} = 100V, R_G = 25Ω, Starting T_J = 25°C
3. I_{SD} ≤ 4A, di/dt ≤ 100A/us, V_{DD} ≤ BV_{DSS}, Starting T_J = 25°C
4. Pulse Test : Pulse width ≤ 300us, Duty cycle ≤ 2%
5. Essentially independent of operating temperature

Typical Characteristics

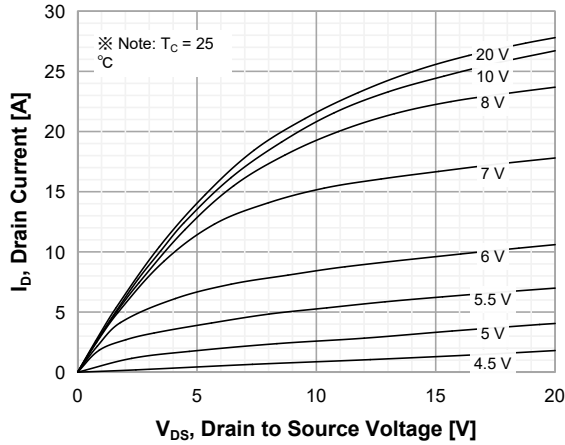

Figure 1. On-Region Characteristics

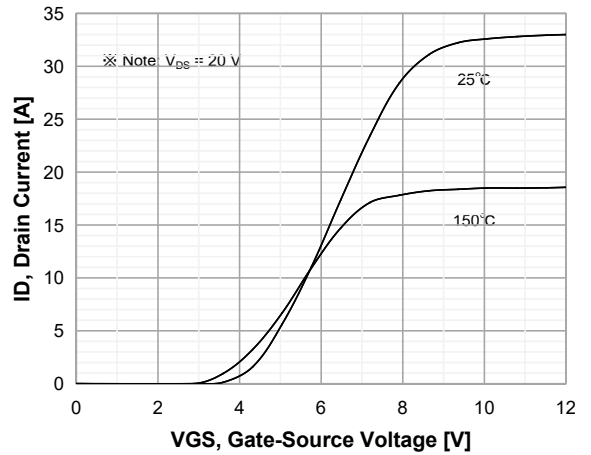

Figure 2. Transfer Characteristics

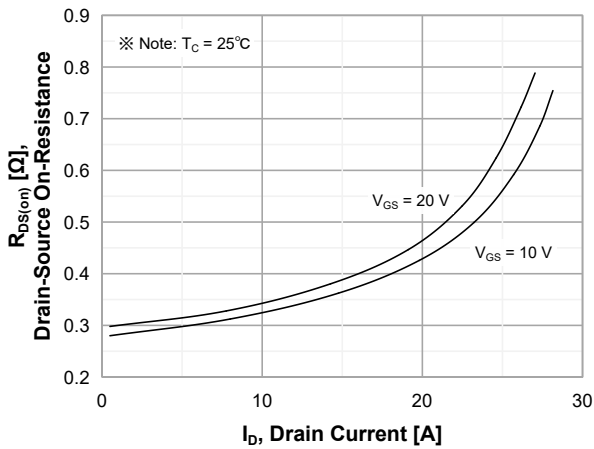

Figure 3. On-Resistance Variation vs Drain Current and Gate Voltage

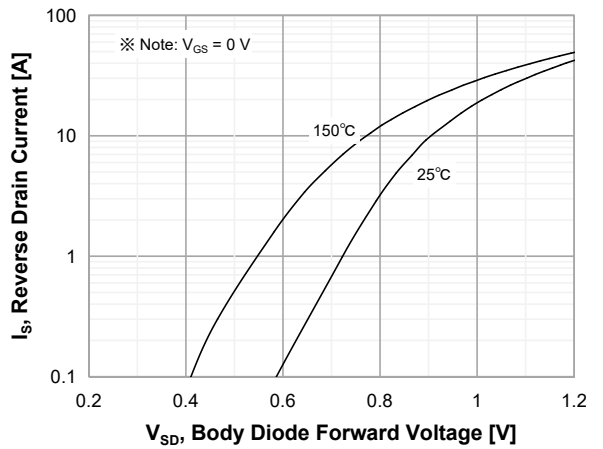

Figure 4. Body Diode Forward Voltage Variation with Source Current and Temperature

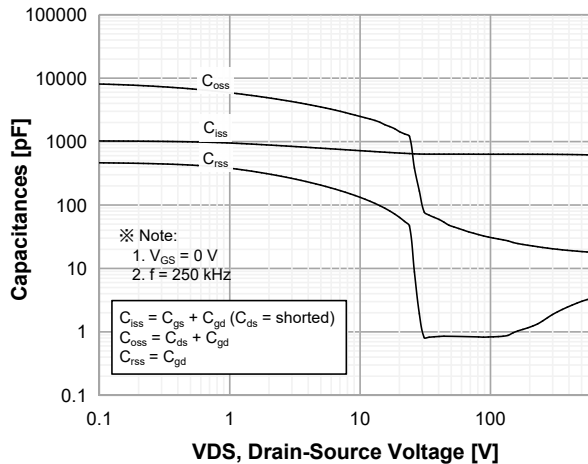

Figure 5. Capacitance Characteristics

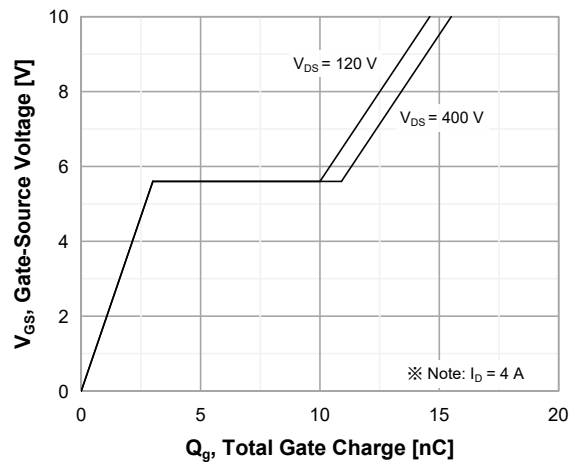

Figure 6. Gate Charge Characteristics

Typical Characteristics (Continued)

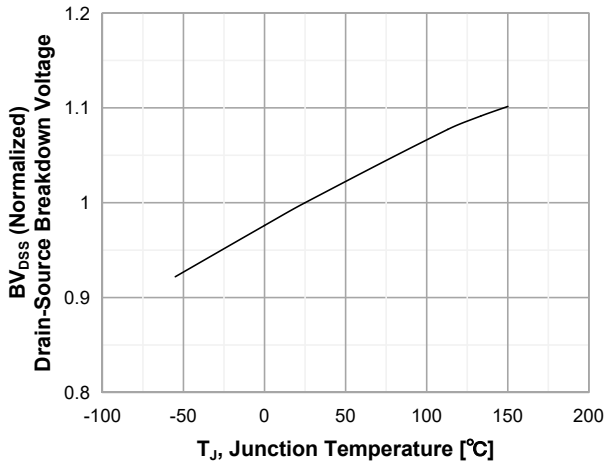

Figure 7. Breakdown Voltage Variation vs Temperature

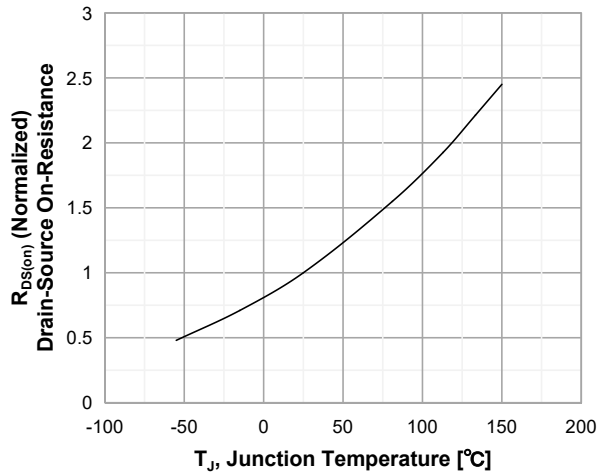

Figure 8. On-Resistance Variation vs Temperature

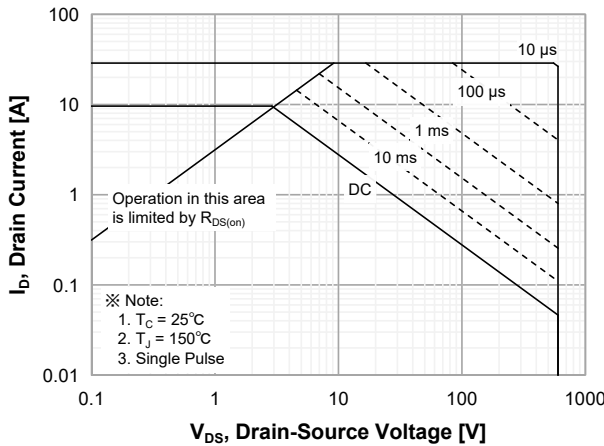

Figure 9. Maximum Safe Operating Area

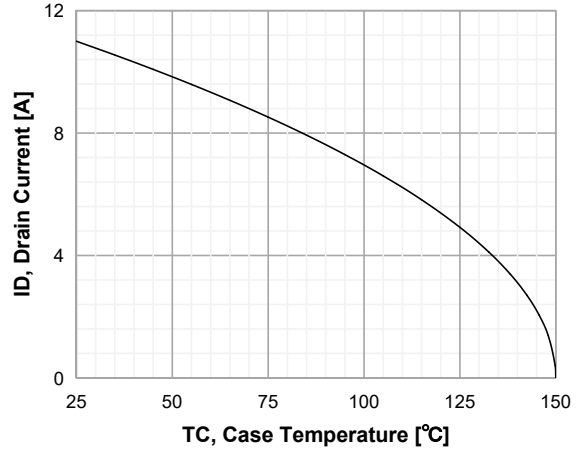

Figure 10. Maximum Drain Current vs Case Temperature

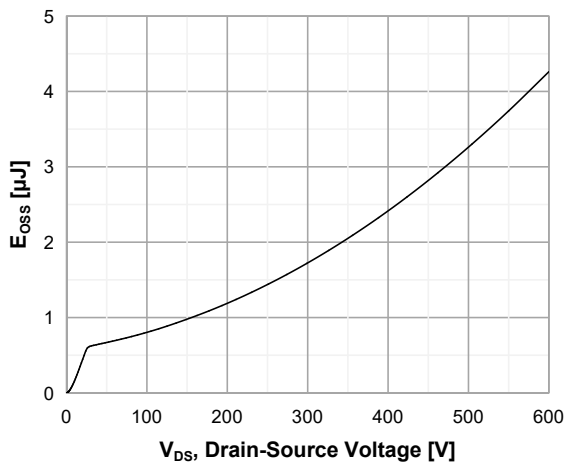

Figure 11. E_{OSS} vs. Drain to Source Voltage

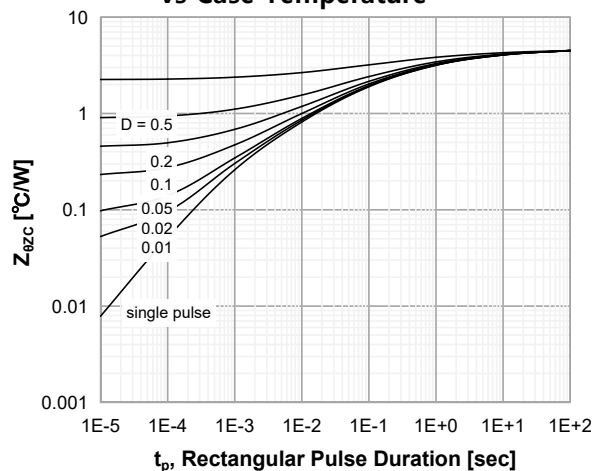
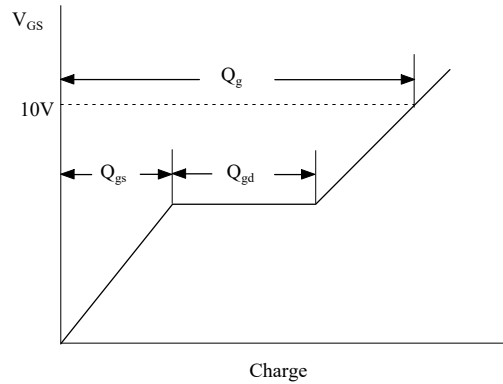
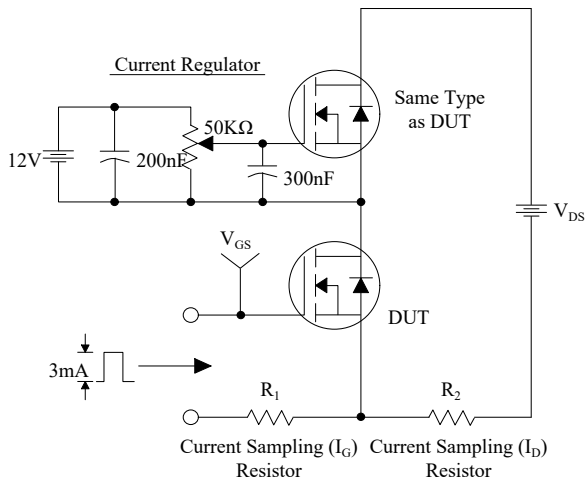
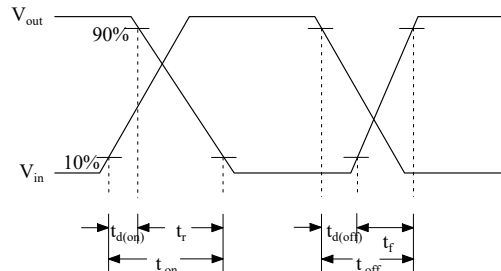
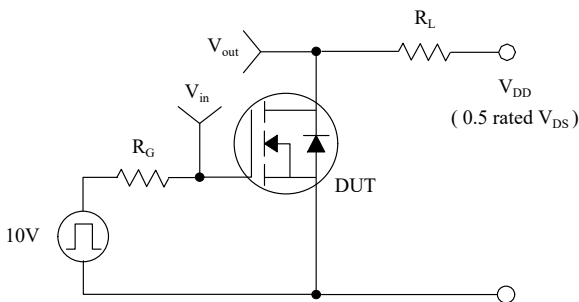

Figure 12. Transient Thermal Response Curve

Gate Charge Test Circuit & Waveform



Resistive Switching Test Circuit & Waveforms



Unclamped Inductive Switching Test Circuit & Waveforms

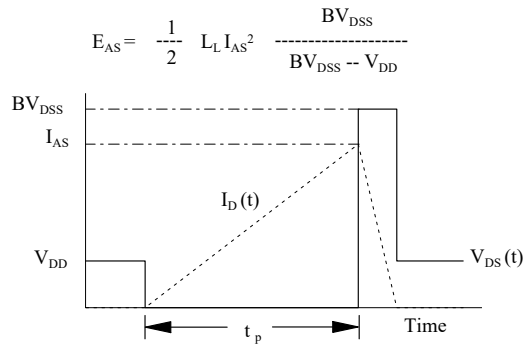
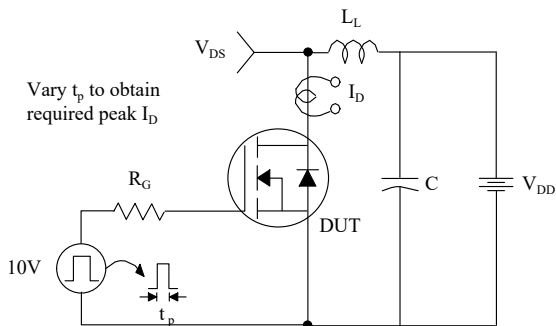

Peak Diode Recovery dv/dt Test Circuit & Waveforms

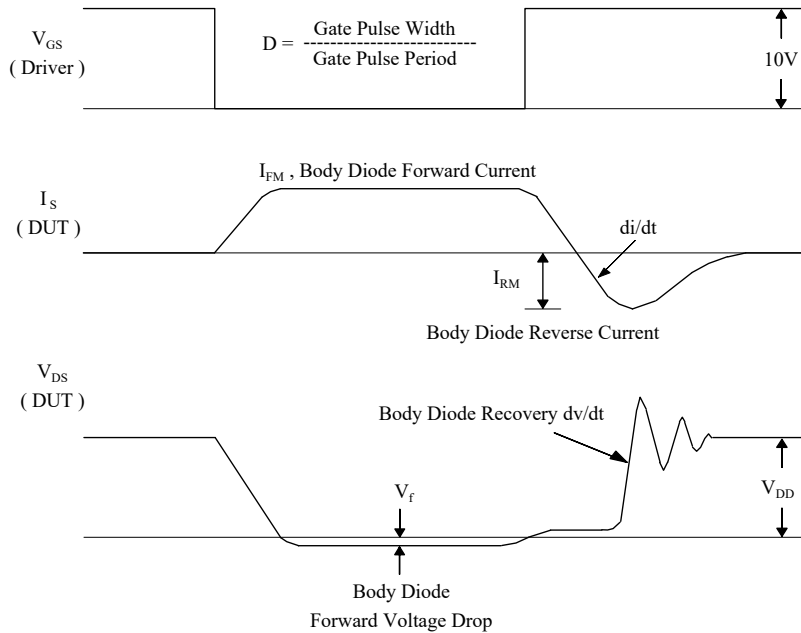
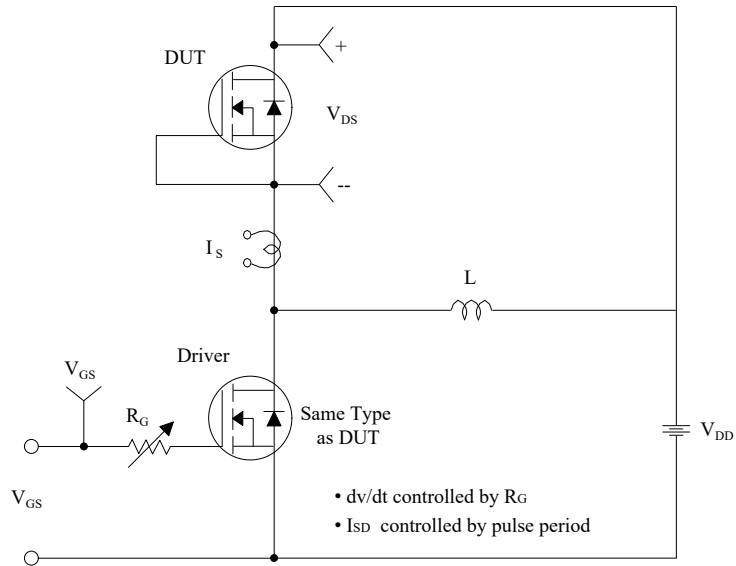

Electrical Characteristics

$T_C = 25^\circ\text{C}$ unless otherwise noted

Symbol	Parameter	Test Conditions	Min	Typ	Max	Units
--------	-----------	-----------------	-----	-----	-----	-------

Off Characteristics

BV_{DSS}	Drain-Source Breakdown Voltage	$V_{GS} = 0\text{ V}, I_D = 250\text{ }\mu\text{A}$	500	--	--	V
$\Delta BV_{DSS} / \Delta T_J$	Breakdown Voltage Temperature Coefficient	$I_D = 250\text{ }\mu\text{A}$, Referenced to 25°C	--	0.59	--	$V/^\circ\text{C}$
I_{DSS}	Zero Gate Voltage Drain Current	$V_{DS} = 500\text{ V}, V_{GS} = 0\text{ V}$	--	--	1	μA
		$V_{DS} = 400\text{ V}, T_C = 125^\circ\text{C}$	--	--	10	μA
I_{GSSF}	Gate-Body Leakage Current, Forward	$V_{GS} = 30\text{ V}, V_{DS} = 0\text{ V}$	--	--	100	nA
I_{GSSR}	Gate-Body Leakage Current, Reverse	$V_{GS} = -30\text{ V}, V_{DS} = 0\text{ V}$	--	--	-100	nA

On Characteristics

$V_{GS(th)}$	Gate Threshold Voltage	$V_{DS} = V_{GS}, I_D = 250\text{ }\mu\text{A}$	3.0	--	5.0	V
$R_{DS(on)}$	Static Drain-Source On-Resistance	$V_{GS} = 10\text{ V}, I_D = 9\text{ A}$	--	212	265	m Ω
g_{FS}	Forward Transconductance	$V_{DS} = 40\text{ V}, I_D = 9\text{ A}$	--	12	--	S

Dynamic Characteristics

C_{iss}	Input Capacitance	$V_{DS} = 25\text{ V}, V_{GS} = 0\text{ V}, f = 1.0\text{ MHz}$	--	3110	--	pF
C_{oss}	Output Capacitance		--	328	--	pF
C_{riss}	Reverse Transfer Capacitance		--	32	--	pF

Switching Characteristics

$t_{d(on)}$	Turn-On Delay Time	$V_{DD} = 250\text{ V}, I_D = 18\text{ A}, R_G = 25\text{ }\Omega$ (Note 4, 5)	--	65	--	ns
t_r	Turn-On Rise Time		--	40	--	ns
$t_{d(off)}$	Turn-Off Delay Time		--	245	--	ns
t_f	Turn-Off Fall Time		--	68	--	ns
Q_g	Total Gate Charge	$V_{DS} = 250\text{ V}, I_D = 18\text{ A}, V_{GS} = 10\text{ V}$ (Note 4, 5)	--	116	--	nC
Q_{gs}	Gate-Source Charge		--	16	--	nC
Q_{gd}	Gate-Drain Charge		--	38	--	nC

Drain-Source Diode Characteristics and Maximum Ratings

I_S	Maximum Continuous Drain-Source Diode Forward Current	--	--	18	A	
I_{SM}	Maximum Pulsed Drain-Source Diode Forward Current	--	--	72	A	
V_{SD}	Drain-Source Diode Forward Voltage	$V_{GS} = 0\text{ V}, I_S = 9\text{ A}$	--	--	1.4	V
t_{rr}	Reverse Recovery Time	$V_{GS} = 0\text{ V}, I_S = 18\text{ A}$,	--	525	--	ns
Q_{rr}	Reverse Recovery Charge	$di_F / dt = 100\text{ A}/\mu\text{s}$ (Note 4)	--	6.2	--	μC

Notes:

1. Repetitive Rating : Pulse width limited by maximum junction temperature
2. $L = 0.5\text{ mH}, V_G = 10\text{ V}, V_{DD} = 50\text{ V}$, Starting $T_J = 25^\circ\text{C}$
3. $I_{SD} \leq 20\text{ A}, di/dt \leq 200\text{ A}/\mu\text{s}, V_{DD} \leq BV_{DSS}$, Starting $T_J = 25^\circ\text{C}$
4. Pulse Test : Pulse width $\leq 300\mu\text{s}$, Duty cycle $\leq 2\%$
5. Essentially independent of operating temperature

TO-220F OUTLINE

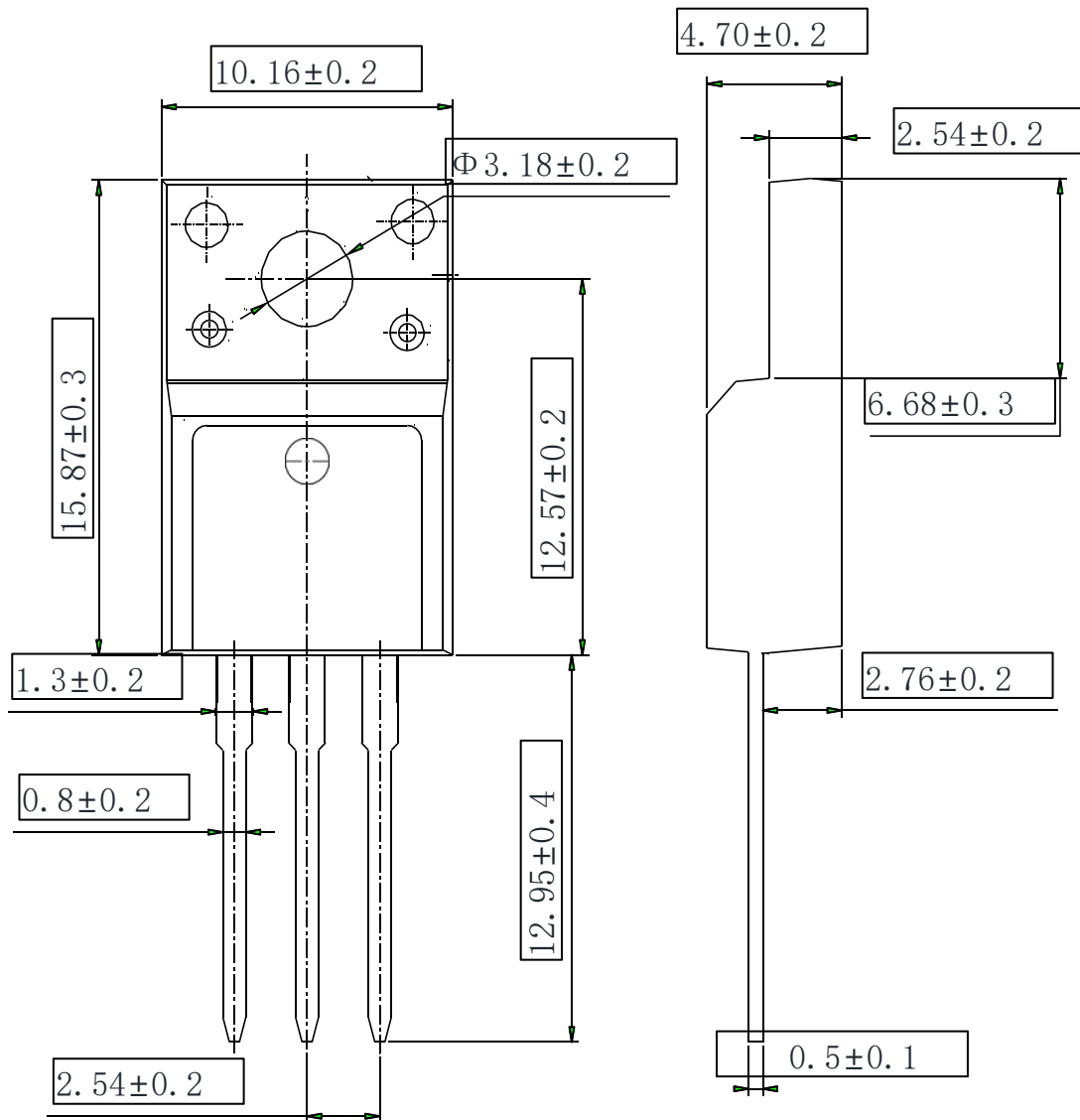

NOTE:

1. The plastic package is not marked as smooth surface $R_a=0.1$; Subglossy surface $R_a=0.8$
2. Undeclared tolerance ± 0.15 , Unmarked fillet $R_{max}=0.25$